





## Аналоги запчастей к модели HDN 4 (Starlinger)

|    |   |   |
|----|---|---|
| 1. |    | <b>HEDDLE BAND BOTTOM - 12</b><br>Ref : 2UF-0079        |
| 2. |    | <b>HEDDLE BAND TOP - 12</b><br>Ref : 2UF-0078           |
| 3. |   | <b>HEDDLE BAND BOTTOM - 20</b><br>Ref : 2UE-0282        |
| 4. |  | <b>HEDDLE BAND TOP - 20</b><br>Ref : 3UD-0281           |
| 5. |  | <b>GROMMET BAND</b><br>Ref : XUB-0011<br>Ref : YVC-0060 |

ООО "ИНВЕНТ СЕРВИС"

117279, г.Москва, ул. Профсоюзная, д. 93а, оф. 234

Тел.: +7 (495) 620 6204; Факс: +7 (495) 620 6205; sales@invent-group.ru; http: www.invent-group.ru





## Аналоги запчастей к модели HDN 4 (Starlinger)

|     |   |   |
|-----|---|---|
| 6.  |    | <p><b>EXCENTER</b><br/>Ref : XGF-0008</p>                         |
| 7.  |    | <p><b>SHUTTLE BODY (PLASTIC)</b><br/>Ref : XUF-0021</p>           |
| 8.  |   | <p><b>COMPLETE SHUTTLE BODY (PLASTIC)</b><br/>Ref : YVC-0174</p>  |
| 9.  |  | <p><b>COMPLETE BEARING BLOCK</b><br/>Ref : YVB-0128</p>           |
| 10. |  | <p><b>BEARING BLOCK</b><br/>Ref : 2AI-0012<br/>Ref : YVA-0102</p> |

**Аналоги запчастей к модели HDN 4 (Starlinger)**

|     |   |   |
|-----|---|---|
| 11. |    | <b>COMPLETE<br/>EXCENTRE WHEEL<br/>Ref : YVB-0124</b> |
| 12. |    | <b>EXCENTRE WHEEL<br/>Ref : 4CD-0286</b>              |
| 13. |   | <b>COMPLETE<br/>SHUTTLE WHEEL<br/>Ref : YVD-0110</b>  |
| 14. |  | <b>SHUTTLE WHEEL<br/>Ref : 4CC-0287</b>               |

## Аналоги запчастей к модели HDN 4 (Starlinger)

|     |   |  |
|-----|---|--|
| 15. |    | <p><b>COMPLETE<br/>CONCOID ROLLER DRIVE</b><br/>Ref : YVE-0107</p> |
| 16. |    | <p><b>CHONCHOID ROLLER</b><br/>Ref : 4CH-0004</p>                  |
| 17. |   | <p><b>COMPLETE<br/>CONCOID ROLLER BRAKE</b><br/>Ref : YVC-0108</p> |
| 18. |  | <p><b>CHONCHOID ROLLER</b><br/>Ref : 4CH-0005</p>                  |
| 19. |  | <p><b>COMPLETE SH. WHEEL</b><br/>Ref : YVE-0125</p>                |





**Аналоги запчастей к модели HDN 4 (Starlinger)**

|     |   |  |
|-----|---|--|
| 20. |  | <b>SHUTTLE WHEEL</b><br>Ref : 4CA-0331<br>Ref : 2CA-1235 |
| 21. |  | <b>COMPLETE<br/>SH. WHEEL MOUNTING</b><br>Ref : YVD-0101 |

## Аналоги запчастей к модели HDN 4 (Starlinger)

|     |   |  |
|-----|---|--|
| 22. |    | <p><b>COMPLETE BANDAGE</b><br/>Ref : YVC-0132</p>                                |
| 23. |    | <p><b>BANDAGE</b><br/>Ref : 3UA-0040</p>   |
| 24. |   | <p><b>HEDDLE SHAFT<br/>DRIVING ARM</b><br/>Ref : 2UB-0016<br/>Ref : YVC-0061</p> |
| 25. |  | <p><b>COMPLETE BRAKE ROLL</b><br/>Ref : YVC-0133</p>                             |
| 26. |  | <p><b>BANDAGE</b><br/>Ref : 3UA-0042</p>   |

**Аналоги запчастей к модели HDN 4 (Starlinger)**

|     |   |  |
|-----|---|--|
| 27. |    | <b>COMPLETE<br/>DEFLECTING PULLEY<br/>Ref : YVC-0003</b> |
| 28. |    | <b>DEFLECTING PULLEY<br/>Ref : 4UA-0010</b>              |
| 29. |   | <b>BRAKE SHEEK<br/>Ref : 3CE-0003</b>                    |
| 30. |  | <b>BRAKE<br/>Ref : 2CB-2088</b>                          |

## Аналоги запчастей к модели HDN 4 (Starlinger)



|     |   |  |
|-----|---|--|
| 31. |    | <p><b>CHONCOID ROLLER</b><br/>Ref : 4UB-0038</p>                 |
| 32. |    | <p><b>CHONCOID ROLLER</b><br/>Ref : 4UB-0039</p>                 |
| 33. |   | <p><b>COMPLETE<br/>INS. FINGER HOLDER</b><br/>Ref : YVA-0097</p> |
| 34. |  | <p><b>HOLDER</b><br/>Ref : 3UG-0028</p>                          |
| 35. |  | <p><b>COMPLETE<br/>BEARING BLOCK IN FRONT</b><br/>Ref : YV</p>   |



## Аналоги запчастей к модели HDN 4 (Starlinger)

|     |   |   |
|-----|---|---|
| 36. |    | <b>BEARING BLOCK<br/>IN FRONT</b><br>Ref : 3UC-0023   |
| 37. |    | <b>COMPLETE<br/>BEARING BLOCK</b><br>Ref : YV         |
| 38. |   | <b>BEARING BLOCK</b><br>Ref : 3UB-0022                |
| 39. |  | <b>COMPLETE<br/>BRACKET BEARING</b><br>Ref : YVA-0099 |
| 40. |  | <b>BRACKET BEARING</b><br>Ref : 2UF-0044              |





## Аналоги запчастей к модели HDN 4 (Starlinger)

|     |   |   |
|-----|---|---|
| 41. |    | <p><b>COMPLETE<br/>BRACKET BEARING</b><br/>Ref : YVA-0100</p> |
| 42. |    | <p><b>BRACKET BEARING</b><br/>Ref : 2UB-0045</p>              |
| 43. |   | <p><b>BELT PULLEY</b><br/>Ref : 4UA-0015</p>                  |
| 44. |  | <p><b>CONNECTING ROD</b><br/>Ref : 2UA-0012</p>               |
| 45. |  | <p><b>CLAMPING PIECE</b><br/>Ref : 3UA-0013</p>               |
| 46. |  | <p><b>DISC</b><br/>Ref : 3UD-0091</p>                         |





## Аналоги запчастей к модели HDN 4 (Starlinger)

|     |   |  |
|-----|---|--|
| 47. |    | <p><b>SPRING</b><br/>Ref : 3UD-0092</p>        |
| 48. |    | <p><b>CLAMPING</b><br/>Ref : 2UB-0024</p>      |
| 49. |    | <p><b>CLAMPING</b><br/>Ref : 3UB-0030</p>      |
| 50. |  | <p><b>COVER</b><br/>Ref : 3UE-0031</p>         |
| 51. |  | <p><b>BRAKE BEARING</b><br/>Ref : 3UC-0034</p> |





## Аналоги запчастей к модели HDN 4 (Starlinger)

|     |   |   |
|-----|---|---|
| 52. |    | <b>HOLDER</b><br>Ref : 4UD-0046   |
| 53. |    | <b>BEARING COVER</b><br>Ref : 4UA-0027  |
| 54. |   | <b>BACKSTOP</b><br>Ref : 3UE-0043   |
| 55. |  | <b>REFLECTOR HOLDER</b><br>Ref : 4UA-0047   |
| 56. |  | <b>COMPLETE INS. FINGER<br/>                 SHUT DOWN DEV.</b><br>Ref : YVC-0098 |





## Аналоги запчастей к модели HDN 4 (Starlinger)

|     |   |   |
|-----|---|---|
| 57. |    | <p><b>REFLECTOR<br/>(WITHOUT MIRROR)</b><br/>Ref : 4CB-0006</p> |
| 58. |    | <p><b>CLAMP</b><br/>Ref : 4UA-0029</p>                          |
| 59. |   | <p><b>FELLOE</b><br/>Ref : 3UB-0041</p>                         |
| 60. |  | <p><b>SPACER</b><br/>Ref : 4UC-0279</p>                         |
| 61. |  | <p><b>BEARING</b><br/>Ref : 4UA-0093</p>                        |





**Аналоги запчастей к модели HDN 4 (Starlinger)**

|     |   |                                |
|-----|---|--------------------------------|
| 62. |    | <b>CAP</b><br>Ref : 4UA-0020   |
| 63. |    | <b>COVER</b><br>Ref : 4UA-0326 |
| 64. |   | <b>CAP</b><br>Ref : 4UA-0018   |
| 65. |  | <b>CAP</b><br>Ref : 4UA-0052   |

## Аналоги запчастей к модели HDN 4 (Starlinger)

|     |   |   |
|-----|---|---|
| 66. |    | <p><b>BUSH F. SPRING</b><br/>Ref : 4UC-0035</p> |
| 67. |    | <p><b>BEARING BLOCK</b><br/>Ref : 3WB-0008</p>  |
| 68. |   | <p><b>DRIVE FRAME</b><br/>Ref : 3CD-0300</p>    |
| 69. |  | <p><b>BRAKE BRACKET</b><br/>Ref : 3CE-0301</p>  |

## Аналоги запчастей к модели HDN 4 (Starlinger)

|     |   |   |
|-----|---|---|
| 70. |    | <p><b>SPRING STRECHER</b><br/>Ref : 4IC-0004</p>                                |
| 71. |    | <p><b>COMPLETE<br/>SPR. LOADED ARM</b><br/>Ref : YV-0106<br/>Ref : 4IA-0003</p> |
| 72. |  | <p><b>PIN</b><br/>Ref : VZS-5001</p>  |
| 73. |  | <p><b>PIN</b><br/>Ref : VZS-7000</p>  |
| 74. |  | <p><b>PIN</b><br/>Ref : VZS-5000</p>  |





ООО "ИНВЕНТ СЕРВИС"

117279, г.Москва, ул. Профсоюзная, д. 93а, оф. 234

Тел.: +7 (495) 620 6204; Факс: +7 (495) 620 6205; sales@invent-group.ru; http: www.invent-group.ru







## Аналоги запчастей к модели HDN 4 (Starlinger)

|     |   |                                 |
|-----|---|---------------------------------|
| 75. |    | <p>PIN<br/>Ref : VZS-5002</p>   |
| 76. |    | <p>SCREW<br/>Ref : 4TC-0001</p> |
| 77. |   | <p>SCREW<br/>Ref : NSE-1000</p> |
| 78. |  | <p>AXLE<br/>Ref : 4RC-0011</p>  |
| 79. |  | <p>PIN<br/>Ref : VZS-7001</p>   |





## Аналоги запчастей к модели HDN 4 (Starlinger)

|     |   |  |
|-----|---|--|
| 80. |    | <p><b>AXLE</b><br/>Ref : 4RB-0023</p>          |
| 81. |    | <p><b>PINTLE</b><br/>Ref : 4RC-0014</p>        |
| 82. |   | <p><b>BOLT</b><br/>Ref : 4RB-0018</p>          |
| 83. |  | <p><b>BOLT</b><br/>Ref : 4RB-0019</p>          |
| 84. |  | <p><b>EXCENTRE BOLT</b><br/>Ref : 4RG-0017</p> |

## Аналоги запчастей к модели HDN 4 (Starlinger)

|     |   |  |
|-----|---|--|
| 85. |    | <p><b>BALANCING</b><br/>Ref : 4RE-0026</p>   |
| 86. |    | <p><b>SPACER PIPE</b><br/>Ref : 4OB-0004</p> |
| 87. |   | <p><b>SPACER</b><br/>Ref : 4RA-0021</p>      |
| 88. |  | <p><b>SPACER</b><br/>Ref : 4OB--0008</p>     |
| 89. |  | <p><b>SPACER</b><br/>Ref : 4OA--0009</p>     |





## Аналоги запчастей к модели HDN 4 (Starlinger)

|     |   |   |
|-----|---|---|
| 90. |    | <b>COUNTER WEIGHT</b><br>Ref : 4RB-0027 |
| 91. |    | <b>COUNTER WEIGHT</b><br>Ref : 4RA-0028 |
| 92. |   | <b>SINTERED BUSH</b><br>Ref : LGL-1000  |
| 93. |  | <b>WASHER</b><br>Ref : 4RA-0013         |
| 94. |  | <b>NUT</b><br>Ref : NUV-1000            |



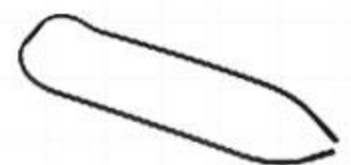

## Аналоги запчастей к модели HDN 4 (Starlinger)

|     |   |   |
|-----|---|---|
| 95. |    | <p><b>COVER</b><br/>Ref : 4RB-0022</p>            |
| 96. |    | <p><b>BOBBIN HOLDER</b><br/>Ref : 4RC-0029</p>    |
| 97. |   | <p><b>BOBBIN HOLDER</b><br/>Ref : 4RC-0030</p>    |
| 98. |  | <p><b>INSERTION FINGER</b><br/>Ref : 4WC-0240</p> |



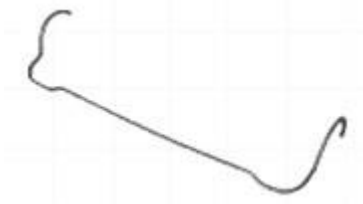

## Аналоги запчастей к модели HDN 4 (Starlinger)

|      |   |   |
|------|---|---|
| 99.  |    | <p><b>INSERTION FINGER</b><br/>Ref : 4WA-0009</p>                 |
| 100. |    | <p><b>INSERTION FINGER</b><br/>Ref : 4WA-0010</p>                 |
| 101. |   | <p><b>TAPE WEIGHT</b><br/>Ref : 4RC-0548<br/>Ref : 4RA-6010</p>   |
| 102. |  | <p><b>GUIDE BRACKET</b><br/>Ref : 2OC-0007<br/>Ref : 3OC-0016</p> |
| 103. |  | <p><b>BRAKE ARM</b><br/>Ref : 3OC-0005</p>                        |

## Аналоги запчастей к модели HDN 4 (Starlinger)





|      |   |  |
|------|---|--|
| 104. |    | <p><b>BRACKET</b><br/>Ref : 3FF-0009</p>         |
| 105. |    | <p><b>CLAMP RING</b><br/>Ref : VSR-3002</p>      |
| 106. |  | <p><b>COMPENSATOR 2,1</b><br/>Ref : 2CE-0042</p> |
| 107. |  | <p><b>COMPENSATOR 2,5</b><br/>Ref : 2CE-1740</p> |
| 108. |  | <p><b>HEDDLE WIRE</b><br/>Ref : TOS-1007</p>     |

## Аналоги запчастей к модели HDN 4 (Starlinger)





|      |   |   |
|------|---|---|
| 110. |    | <p><b>HEDDLE WIRE</b><br/>Ref : 3TA-1027</p>  |
| 111. |    | <p><b>SPRING</b><br/>Ref : 4FB-0003</p>   |
| 112. |  | <p><b>SPRING HOLDER</b><br/><b>HEDDLE WIRE</b><br/>Ref : 4FA-0004<br/>Ref : 10S-1048<br/>Ref : 4FA-0495</p> |
| 113. |  | <p><b>SPRING</b><br/>Ref : 4FC-0006</p>   |
| 114. |  | <p><b>PRESSURE SPRING</b><br/>Ref : 4FA-0008</p>  |



## Аналоги запчастей к модели HDN 4 (Starlinger)

|      |   |  |
|------|---|--|
| 115. |    | <p><b>MAXI-DRAG</b><br/>Ref : HDG-1020</p>                         |
| 116. |    | <p><b>RUBBER BAND 50 X 2</b><br/>Ref : HDG-1073-8800</p>           |
| 117. |   | <p><b>NIPPLE</b><br/>Ref : TSE-1000</p>                            |
| 118. |  | <p><b>CERAMIC COLLAR EYELET</b><br/>Ref : 4TA-0003</p>             |
| 119. |  | <p><b>CHROME-LEATHER</b><br/>INCL. TESA FIX<br/>Ref : HDL-1012</p> |

## Аналоги запчастей к модели HDN 4 (Starlinger)

|      |   |  |
|------|---|--|
| 120. |    | <p><b>BRAKE PAD</b><br/>Ref : 4CC-4893</p>                           |
| 121. |    | <p><b>BRAKE PAD</b><br/>Ref : 4DA-0113</p>                           |
| 122. |   | <p><b>FOAM</b><br/>Ref : HDS-1005</p>                                |
| 123. |  | <p><b>SIGHT FEED OILER</b><br/>(D-75 / D-150)<br/>Ref : TSE-1014</p> |
| 124. |  | <p><b>MAGNETIC SENSOR</b></p>  |